



Natural wood
Made to last

Installation Guide



Kebony Shiplap

#K90XX514 – 1×6 Clear 90 Degree Shiplap

#2242 – 1×6 Character 60 Degree Shiplap w/Shadow Line

#2216 – 1×6 Character 90 Degree Shiplap

Please read these guidelines carefully, and if you have any questions, **e-mail: info@kebonny.us** or **call: +1 833.795.8660**

www.kebonny.us
    [@kebonnyusa](https://www.instagram.com/kebonnyusa)

Preparing for Installation

SAFETY GUIDELINES

Installing Kebony Shiplap siding is a construction project, therefore you should wear protective clothing and safety equipment such as, but not limited to, safety glasses, gloves, long sleeves, and a mask, particularly when cutting wood.

The installer is responsible for identifying and following all building codes and construction safety practices. Kebony accepts no liability or responsibility for the improper installation of this product.

Kebony Shiplap siding may not be suitable for every application, and it is the sole responsibility of the installer to ensure that Kebony Shiplap siding is fit for the intended use. Because all installations are unique, it is also the installer's responsibility to determine specific requirements for each siding application.

Kebony recommends that all applications be reviewed by a licensed architect, engineer or local building official before installation.

STORAGE

Kebony should not be exposed directly to the elements before installation. Kebony should be kept enclosed in its original packaging or re-wrapped if previously opened. Ideally, Kebony should also be stored indoors or under cover. Additionally, it's good practice to flip over (reverse) the top boards so that they are face down, i.e. the top face of the board is not directly exposed to the elements. This will help reduce the likelihood of having boards with different degrees of fading.

PREP

Perform all necessary preparatory work for your specific project, (e.g. building wrap, flashing, window frames, etc.)

Metal Fixture Considerations: Kebony can be fastened to, or be in contact with aluminum, enameled, powder-coated or foiled fixtures without concern for discoloration. In some cases, surface water run-off from Kebony wood can result in the discoloration of adjacent materials. For example, it could cause black stains on zinc fixtures or polished copper.

Drainage and run-off from galvanized or iron-based fixtures onto Kebony can result in black discoloration of the wood. With respect to metal framing, it is important to ensure that there is no direct contact between Kebony and the exposed metal surfaces. This may require the use of a G-tape or some sort of butyl tape to create a separation between the metal and the boards.

Water run-off from Kebony onto copper parts may result in color variations on the copper surfaces. While copper normally goes through surface oxidization to a dark green or black surface color, Kebony will keep copper shiny with the original copper color on the affected surfaces.

RECOMMENDED TOOLS & EQUIPMENT



Electric Saw (Table, Chop etc.)

- 72-tooth or greater saw blade with carbide teeth



Miter saw

- 72-tooth or greater saw blade with carbide teeth



Drill (Cordless or Corded)

- With Carbide Drill Bit for Pre-Drilling



Ladders and/or scaffolding

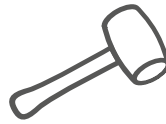

Rubber Mallet



Level



T-bevel



Hammer



Chalkline



Laser Level

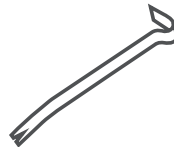

Flat pry bar



Utility Knife



Measuring Tape



Pencil

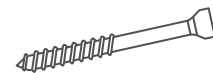

Trim Head Stainless Steel Screws
(Or Starborn Pro Plug® System for
Kebony Clear)

GENERAL INSTALLATION GUIDELINES

Kebony Shiplap siding can be installed horizontally or vertically.

Ground Clearance: Allow for 12" clearance above grade.

Fastener type: Use stainless steel screws made from 304 or 316 stainless depending on site conditions and proximity to seawater.

Clear: All holes must be pre-drilled. Screw head size, length, and stainless steel grades are to be selected by the installer based on site specifics. If using the hidden fastener *Pro Plug® System for Kebony Clear Wood (see below), 2-1/2" screws are included with the System. Follow the edge and end distance fastening rules detailed below. **DO NOT USE NAILS.**

Character: Self-drilling stainless steel screws must be used to avoid the need for pre-drilling. Otherwise, all holes must be pre-drilled. Screw head size, length, and stainless steel grades are to be selected by the installer based on site specifics. Follow the edge and end distance fastening rules detailed below. **DO NOT USE NAILS.**

Face Fastening:

Clear: Face fasteners can be hidden using the Pro Plug® System for Kebony Wood*.

Character: All fasteners are exposed. The Pro Plug® System is only for Kebony Clear.

Spans:

Clear: Secure each board at each end, and up to a maximum 24" span between fasteners.

Character:

Horizontal: Secure each board at each end, and up to a maximum 24" span between fasteners.

Vertical: If the wall is less than 9' tall, then secure each board at each end, and up to a maximum 24" span between fasteners. If the wall is more than 9' tall, then secure each board at each end, and up to a maximum 16" span between fasteners.

Cross-cutting and Ripping Kebony: For Kebony Clear - standard copy re no end sealing for Clear. When ripping or cross-cutting Kebony Character, the exposed heartwood must be treated with an anti-parasite/fungal agent. Follow the manufacturer's instructions.

Drip-Edge: To ensure proper drainage, all bottom board edges should be cut on an angle with a drip edge of a minimum of 20 degrees.

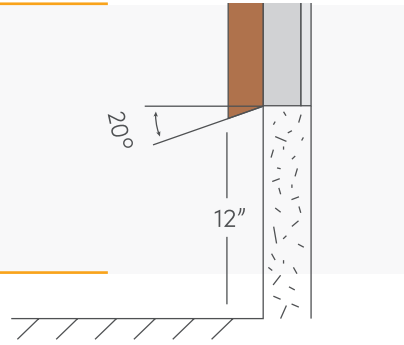

Butt-jointing boards: When butt jointing siding, cut ends at 45 degree angles to form an overlapping joint (Scarf Joint). This is particularly important for vertical installation. Ensure joints meet on studs, blocking or furring strips. The cut should slope downward from the back towards the front.

Do not pre-drill or fasten Kebony Clear within 1" of the side edge.

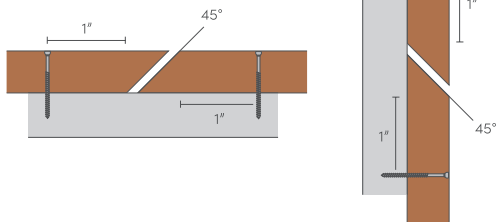

Do not pre-drill or fasten Kebony Character within 5/8" of the side edge.

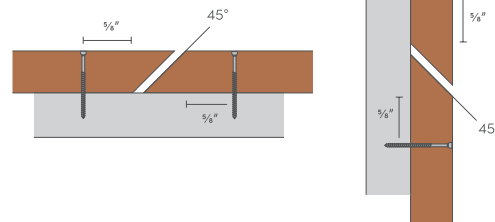

Clear: At the board ends, do not drill within 4/5" of the end of the board. Always pre-drill.

Character: At the board ends, do not drill within 1" of the end of the board. It is required to always pre-drill at the board ends.

HORIZONTAL APPLICATIONS

Kebony Shiplap can be installed one of two ways.

- A** Directly on top of a suitable house drainage wrap.
- B** Kebony Shiplap can alternatively be installed in a rainscreen configuration, fastened to blocking, or furring strips or rainscreen drainage mat systems.

1

Begin at the bottom and work up. Set a level line across all walls using a conventional or laser level. Face the channeled edge upward.

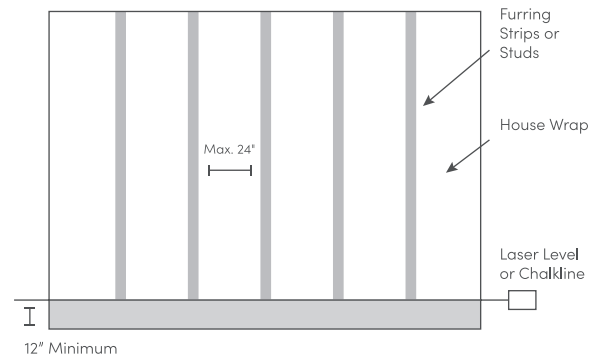

All Shiplap boards require face-fastening. Do not use nails.

2

With the first bottom board, pre-drill and face fasten the first screw $\frac{1}{3}$ of the way up the board. When face-fastening Kebony Clear, you may use the optional *Pro Plug® System for Kebony Clear Wood to hide the screw heads.

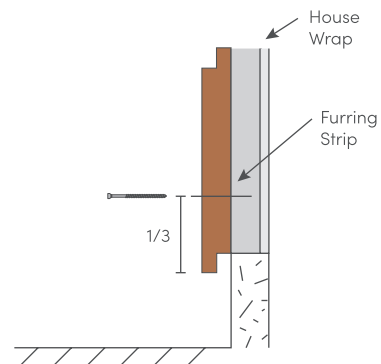

3

Measure and cut your next board to length. Overlap the board over the bottom board and ensure a minimum $\frac{1}{8}$ " gap between the boards to allow for expansion of the wood. Pre-drill and face fasten the board $\frac{1}{3}$ of the way up the board. When face-fastening Kebony Clear, you may use the optional *Pro Plug® System for Kebony Clear Wood to hide the screw heads.

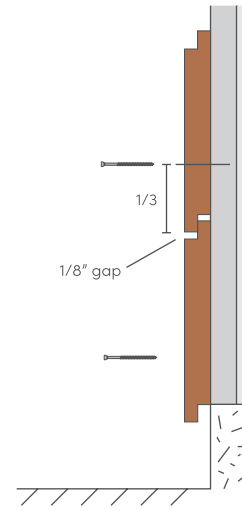

4

Repeat this pattern up the wall until you get to the roof line.

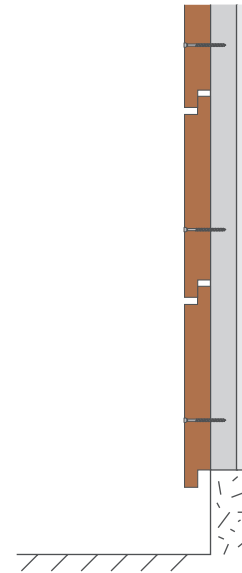

5

Top board(s) at the roofline may need to be custom cut. If the top is horizontal, the top board may need to be ripped to width and should also be face-fastened. Use one fastener if the board is less than 3" wide and two fasteners if the board is greater than 3" wide. If the roofline has a slope, multiple boards will likely have to be cut at angles on the end(s). Various tools are available to help determine the angle.

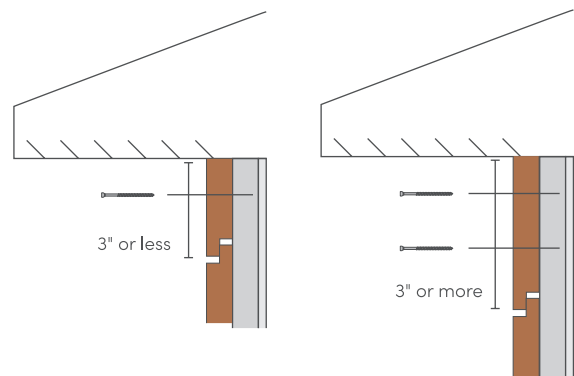

When ripping or cross-cutting Kebony Character, the exposed heartwood must be treated with an anti-parasite/fungal agent. Follow the manufacturer's instructions.

VERTICAL APPLICATIONS

Kebony Shiplap can be installed one of two ways.

A

Directly on top of a suitable house drainage wrap.

B

Kebony can alternatively be installed in a rainscreen configuration, fastened to blocking, furring strips or rainscreen drainage mat systems.

1

Start at one corner with the channeled edge toward the adjacent wall. Use a level to ensure the first board is installed plumb. The channeled edge may need to be trimmed to ensure a flush fit.

Kebony Character installed vertically over 9' requires 16" fastener spacing rather than 24".

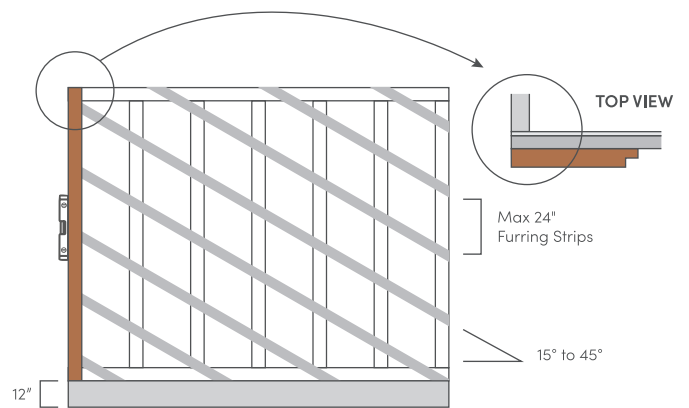

Corners details are the choice of the architect and project owner. There are many options including, but not limited to, mitered corners, corner boards, trim boards, flush, beveled, lap, etc.

2

Pre-drill and face screw the half of the first board closest to the edge. When face fastening Kebony Clear, you may use the optional *Pro Plug® System for Kebony Clear Wood to hide the screw heads.

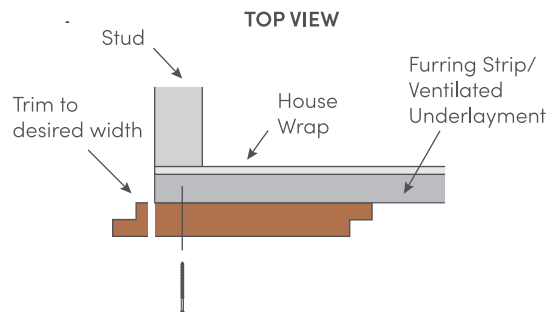

3

Measure and cut your next board to length. Overlap the board over the first board and ensure a minimum $\frac{1}{8}$ " gap between the boards to allow for expansion of the wood. Pre-drill and face fasten the board $\frac{1}{3}$ of the way up the board. When face-fastening Kebony, you may use the optional Starborn Pro Plug® System for Kebony to hide the screw heads.

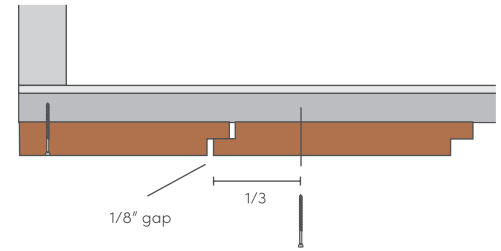

4

Repeat this pattern across the wall.

